



EV Tower

Future-proofing your EV installations with an award-winning multiplate design.

Supplied with stainless steel fixings, the EV Tower is suitable for all applications and easy to assemble, including an interchangeable plate to accommodate any EV charger available in the market.

Produced for durability, each pole is weather resistant and built to last, coming with a 3-year warranty as standard.

Compatible with over 40+ of the leading EV chargers, making it your all-in-one charge master. Just one pole is able to serve numerous chargers.

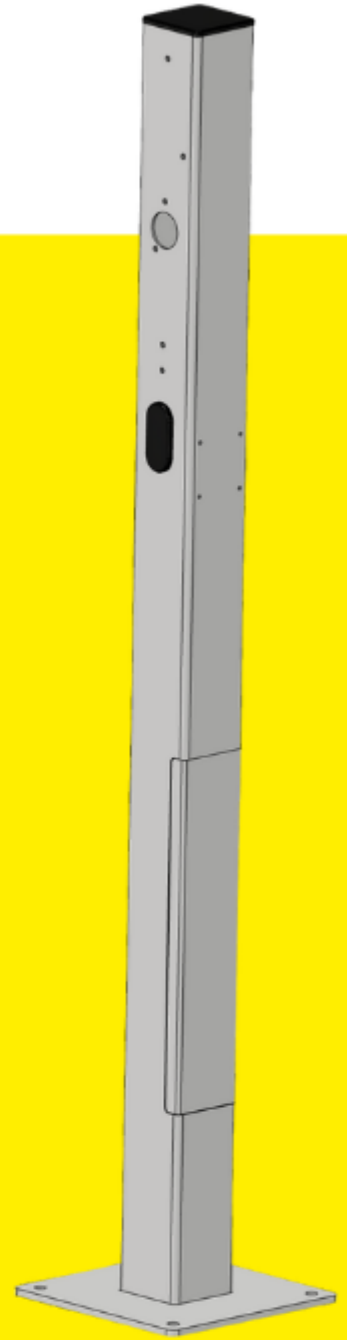

EV Block Mini

EV Block Mini - Specifically designed for the EV Tower for domestic and light commercial installations.

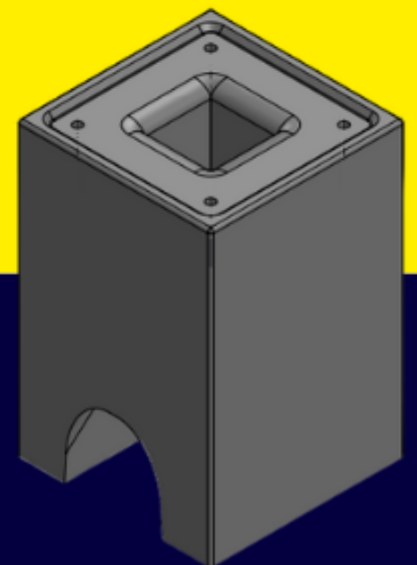

EV BLOCKS.COM



EV BLOCKS.COM



ELECTRIC VEHICLE CHARGER INSTALLATION BLOCKS

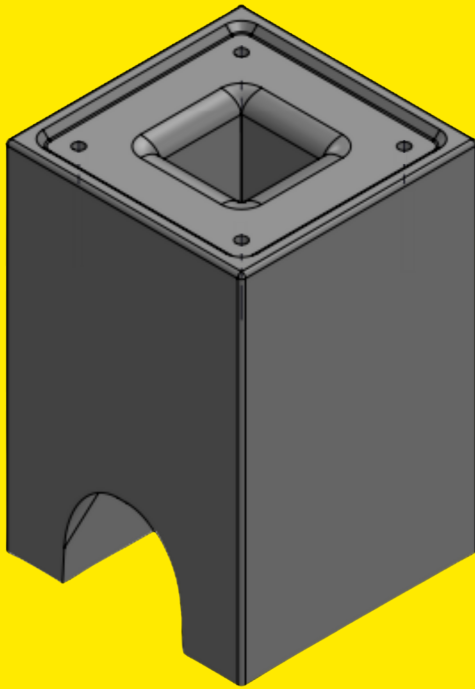

300 X 300 DATA SHEET

EV BLOCK MINI

- Pre-Cast Concrete EV charger base with specifically for an EV Tower
- Uniform finish every time
- 100% Recyclable
- Can be installed in any weather conditions



 LENGTH	300MM
 WIDTH	300MM
 HEIGHT	450MM

 BLOCK WEIGHT	68KG
 PLATE WEIGHT (OPTIONAL)	1 KG
 EV BLOCK TOTAL WEIGHT	68 - 69KG

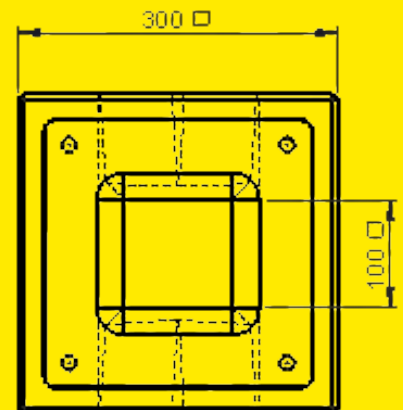
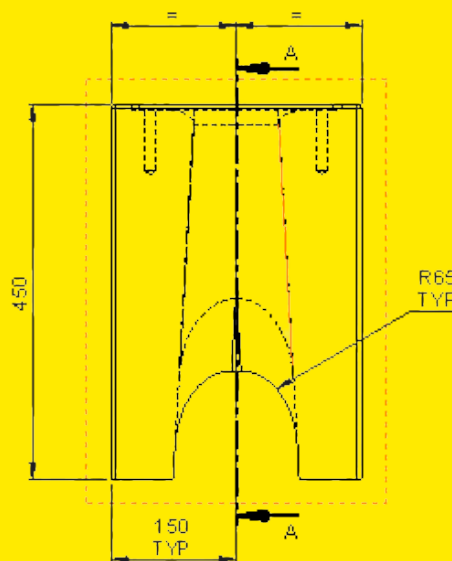
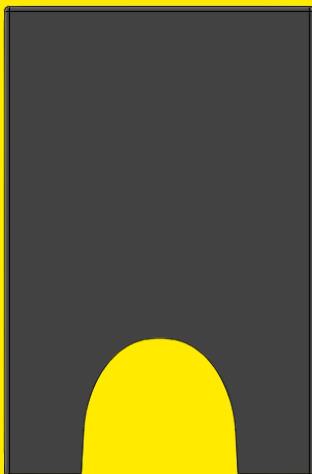

ALL MEASUREMENTS IN MILLIMETRES

01733 513 777

info@evblocks.com



**ENGINEERED
TO SAVE YOU TIME
AND MONEY**